

Integrated Wi-Fi and LoRa network on UAVs for localizing people during SAR operations

Antonello Calabrò

Institute of Information Science and Technologies (ISTI)

National Research Council (CNR)

Pisa, Italy

antonello.calabro@isti.cnr.it

Romeo Giuliano

Dept. of Engineering Science

Guglielmo Marconi University

Rome, Italy

r.giuliano@unimarconi.it

Abstract—In distress and crisis situations, the way how the rescuers answer is extremely important and critical. Rapidity on which Search and Rescue (SAR) operations are deployed and executed may have a high impact on the physical and psychological health of the user in distress. The proposed tool aim in localizing users in areas where any wired or wireless access communication has been interrupted or not working properly like earthquakes areas or mountains where no cellular signal are available. The proposed system is deployed on top of a drone capable to detect Wi-Fi beacons generated by distressed user's device Wi-Fi interface. Beacons acquired are analyzed through the Complex Event Processor and after being aggregated with the acquired GPS position sent to the ground station using LoRa radio transmission protocol. The system has been tested in a woods scenario for simulating the absence of the mobile cellular signal and validating the proposed tracking approach.

Index Terms—LoRa, Search and Rescue, monitoring, UAV.

I. INTRODUCTION

Nowadays, *UAS (Unmanned Aircraft Systems)* are used in several daily life contexts: from the entertainment video recording to the e-commerce delivery. UAS has been initially used only in industry and government context with high development and maintenance costs. One of the emerging environment on which *UAS* are used nowadays, is the context related to the *SAR - Search and Rescue* activities. SAR operations are executed by national and international government to search and rescue people missing or in distress situations. Usually, the research activities led by national government corps are executed through image capture by means of cameras installed on top of the *UAV* and only in particular cases different equipment like thermal imaging camera are used.

In this paper we propose a novel approach for executing *SAR* operations by means of drones equipping a commercial drone with a system able to capture Wi-Fi beacons generated by any device, analyze it on board through a Complex Event Processor (CEP) and send a notification, that contains GPS position and information about the acquired signal, to a ground station. Due to harsh environment and large distances that may exists between the drone in flight and the ground station, the *UAS* has been equipped with a Long Range (LoRa) radio system device for communicating with the ground station. The paper is organized as follows: Section II reports related

work, whereas the conceived system is composed by three enabling technologies: *UAS, LoRa, Monitoring and Complex Event Processing*. Section III presents the architecture of the provided system highlighting the core components and their interactions. To better clarify the potentialities of the proposed approach, in Section IV, a use case in a woods scenario is shown. A preliminary TestBed executed in a controlled environment is presented in Section V and finally Section VI concludes the paper and reports the future work.

II. BACKGROUND & RELATED WORKS

In the following, we focus on three main aspects that equally contributes to the proposed *SAR* systems: the *UAS* technologies, focusing on the differences between the state of the art of the existing Unmanned Aircraft System used for Search and Rescue operation; the Monitoring infrastructure, focusing on the existing monitoring systems enhanced with a CEP feed by rules and their possible evolution in terms of event analysis; and the *LoRa* technologies, highlighting aspects related to the IoT world and the advantages provided by this enabling technology.

A. Search and Rescue systems based on UAS

The majority of the system taken in account, ground their analysis on image analysis [1], executed directly on top of the drone or sending data directly to a ground station for the sampling [2], [3]. Some systems, focused on the localization of person involved in avalanches, are connected with avalanche transceiver [4]. Other systems are focused in using *UAS* catastrophic scenarios like heartquakes or other natural disasters [5], [6]; while in [7] mobile networks are exploited for localizing subjects during *SAR* operations.

In general, approaches related to the discovery of objects/person body are executing their images or data analysis following one of the three approach proposed in Figure: 1:

(a) directly on board of the drone (it may requires high computation resources depending of the used framework); (b) in cloud, transferring data to a remote platform in order to execute the analysis (it requires that in the area on which the drone is executing *SAR* operations a network connection capable to support the transmission of the data to analyse is

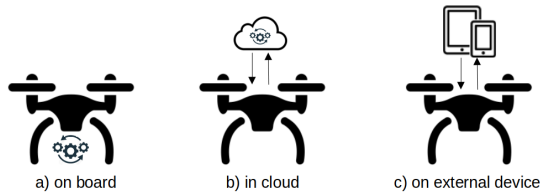

Figure 1. Approaches in data analysis on drones

available); (c) on external devices like smartphones or tablet (usually used as device for piloting drone).

The first approach, executing the analysis on board, avoid problems related to the transmission of the acquired data but would not resolve issues related to the extra power supply needed to power up the devices on top of the drone and the relatives performances. Sometimes, on top of the drones, there is not enough calculating capacity for executing some machine-learning algorithms and the weight due to the required battery are not conform to the flight requirement elicited by the drone. For this reason, the second option (b) has been evaluated: sending data to a cloud platform in order to externalize calculation. This method is based on the transmission of data to an external server. The connectivity requirement may interfere with the deployment of the system in harsh environments where 3G/4G coverage may be limited or not present, making it become useless the system. Last method (c), aim to overtake the issues related to (a) and (b) allocating calculation on mobile devices, like smartphones or mobile phones, located on the ground. Even thought in the last years mobile devices performances has been increased, there is not enough calculation power that may satisfy the requirement of image analysis algorithm in order to consider solved the issue related to the consumption and calculation power required.

B. LoRa

LoRa technology has been widely used in the *Internet of Things (IoT)* world due to its transmission performance over long distances, the low power consumption and limited operational costs. Existing technologies like 3G/4G, if compared, will result ineffective in terms of scalability and energy consumption. This is also brought by the different design requirements that should take in account the increasing amount of bandwidth required by devices. In the near future, through 5G network slicing feature, this may change. *LoRa* related works are mainly focused on four areas: (i) experiments for evaluating performances of *LoRa* and *LoRaWan* networks [8], [9]; (ii) usage of LP-WAN technologies on IoT domain [10], [11] and their application on the farming systems [12] to analyse soil and improve irrigation mechanism in order to create an intelligent ecosystem; (iii) improving *LoRaWAN* architectures has been explored in [13] and in [14] where authors deal with security issues proposing a solution that aims to enhance data protection using a *HSM (Hardware Secure Module)*; (iv) using *LoRa* technologies for *SAR* operations:

in particular in [15] authors use *LoRa* systems to pinpoint humans in distress situation on a mountain scenario; in [16] authors evaluates energy efficiency of a *SAR* system based and in [17] *LoRa* technologies has been used as middleware in a catastrophic scenario.

C. Monitoring and CEP

Monitoring activity has been defined as the process of dynamic collection and interpretation of information in order to understand or to bring out new knowledge [18]. In every monitoring system, five core functions must be provided:

(i) *data collection*: collect raw data generated/acquired by the execution of the system under test (SUT). This operation is executed by means of probes, intercepting messages transmitted across components [19] or through mechanisms provided by the monitored system;

(ii) *local interpretation*: this functionality is referring to the capability of a probe to filter redundant or not relevant data for the sake of the analysis. This action will be executed before sending data in order to reduce the amount of traffic and computation overhead;

(iii) *data transmission*: when a distributed system is monitored, the data transmission process is related to the sending of the data from the SUT to the monitoring platform. This process must be optimized in order to reduce the data traffic avoiding to generate overload on the network that may interfere with the evaluation;

(iv) *data correlation*: the new information acquired by means of probes, instantiated in etherogeneous systems may produce new and emergent knowledge. The resulting Complex Events may represent unknown state of a system or being ground for further analysis. The component that execute those analysis is the CEP;

(v) *notification*: activity focused on providing and making available the results of the analysis done by the CEP in order execute countermeasures (proactive monitoring) [20], or to enrich the knowledge base. The event-based approach allow to abstract the monitored information from the context on which has been generated in order to be aggregated by the inference engine (CEP). An event is the atomic representation of a state transition or of a modification of a parameter of the system under monitoring. This transition is captured by a *Probe*, a piece of software instantiated within the monitored system with the aim to notify, in a specific language, to the CEP.

Monitoring technologies has been widely used for different purposes like vehicular networks where they are integrated in weather or traffic light systems [21], [22], to improve daily life in smart-cities [23] or through the enhancements provided by the CEP, they has been used for verifying and grant access to resources through *Access Control Policies monitoring* [24] or prudent resource usage in smart-cities [25].

III. ARCHITECTURE

Figure: 2 shows main uses cases (UCs) of the system. In the following, UC available to each actor will be described:

- a *Drone pilot* can activate the *Execute Rescue mission* UC. *Execute Rescue mission* includes two more UCs: *Scenario setup* and *TX to ground station*. The UC *Scenario setup* is representing the operation for setting up the system configuration according to the operational scenario of the rescue mission. The second one, called *TX to ground station* is related to the transmission of acquired information to the ground station using *LoRa* radio protocol. This UC may be extended through *TX directly to rescuer* UC that involves directly the *Terrestrial rescuer*.
- a *Terrestrial rescuer* may receive data directly from the drone, as specified with the UC *TX directly to rescuer*, that represents an extension of the basic UC *TX to ground station*. The *Terrestrial rescuer* can receive data about the position of the distressed user even through other channels, eg. personal radio communication if he/she is not in an area covered by the *LoRa* service on board of the drone.

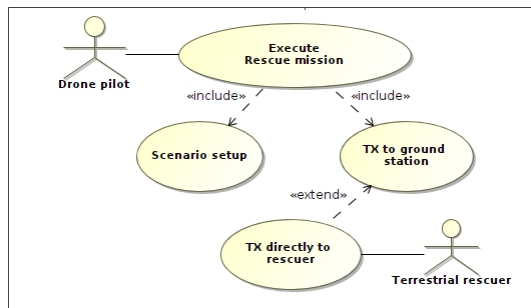

Figure 2. System's use cases

As shown in Figure: 3 through a deployment diagram, the system is composed by three nodes:

- 1) the main one called *OnBoard Node*, that represent the logic of the system managed by a Raspberry-Pi,¹
- 2) the *Ground Node* representing the operative base station that receive notification of data captured by the drone;
- 3) the *Mobile Node*, representing the device owned by the user in distress.

The *OnBoard Node* is composed by four devices: a *Raspberry-PI*, a *LoRa Transmitter*, a *GPS* module and a *Wi-Fi* module. The connection between *OnBoard Node* and *Ground Node* is managed by *Lora Receiver* installed on the *OnBoard Node* and from the *Lora Transmitter* installed on the *Ground Node* through *LoRa* radio modulation. The wireless data generated by the *Mobile Node* are captured by the *Wi-Fi* device on top of the *OnBoard Node*.

A. Hardware technologies

The hardware employed for assembling the system rely on *Raspberry-Pi mod 4 Mod B* board that has been enhanced through: a *Wi-Fi 2.4/5 Ghz High-Gain* antenna that supports

¹<https://www.raspberrypi.org/products/raspberry-pi-4-model-b/specifications/>

monitor mode in order to capture traffic, a *GPS* module and a *LoRa SX1275 ESP32* with dedicated antenna. The system, shown in Figure: 7, is powered by a battery pack capable to provide energy for 35 minutes that has been placed under the *Raspberry-Pi* board with an overall weight of 188 gm.

B. Software technologies

Several technologies has been exploited for developing the system, for space reason we will report only main characteristics: *Monitoring Infrastructure*, *Wi-Fi Probe*, *GPS Probe*, *Serial Port Writer* components has been developed using *OpenJDK Java 16* on *Eclipse EE*. The *CEP* inside the *Monitoring Infrastructure* exploit *Drools*² as inference engine and language for providing rules. The capture of packets over *Wi-Fi* has been carried out through *tcpdump*³ and the middleware in charge of managing messages between probes and *CEP* (*JMS/MQTT Server* component) has been realized by means of *Apache Artemis*⁴. The software artifacts developed for the *Ground node* and *OnBoard Node* and deployed on *LoRa* devices has been made through *Arduino* development IDE integrating libraries for managing *Heltec ESP32 V2*.

C. Localization mechanism

Every *Wi-Fi* device executes a loop scan process [26] sending over the air a frame called *Probe request*. This frame is sent even if the device is connected or not to a *Wi-Fi* network, for this reason, the message is not encrypted. This process allow the device to verify, if around it, an already known *Wi-Fi* network is available in order to connect to it automatically. The same process is executed also in order to verify if a network with an higher signal strength is available for executing handover procedure. In Figure: 4 a graphical representation of the *Probe Request* process is depicted. The client on the left sent a *Probe Request* message on a channel and wait for a response for a specific time-frame [27]. Access points available on the same channel, will respond to the request using a frame called *Probe Response*. In order to localize missing person, the detection of a *Probe request* message in a rescue area, may indicate the presence of a device within it. In a research scenario as a woods, considering that in the surrounding area of a missing person should not be present any other people (devices), the detection of a probing message can be considered an interesting data for the sake of localization. In some cases the *Probe Request* or *Beacon* messages detected, may be confused with messages generated by the devices owned by the *Terrestrial rescuer* operating in the same area. For this reason, the *CEP* can execute a check between the list of mac address associated to *Terrestrial rescuer* and the detected one, avoiding false positives.

D. Event representation

The communication between *Probes* and *Monitoring Infrastructure* exploit a event-based publish-subscribe architecture

²<https://www.drools.org/>

³<https://www.tcpdump.org/manpages/tcpdump.1.html>

⁴<https://activemq.apache.org/components/artemis/>

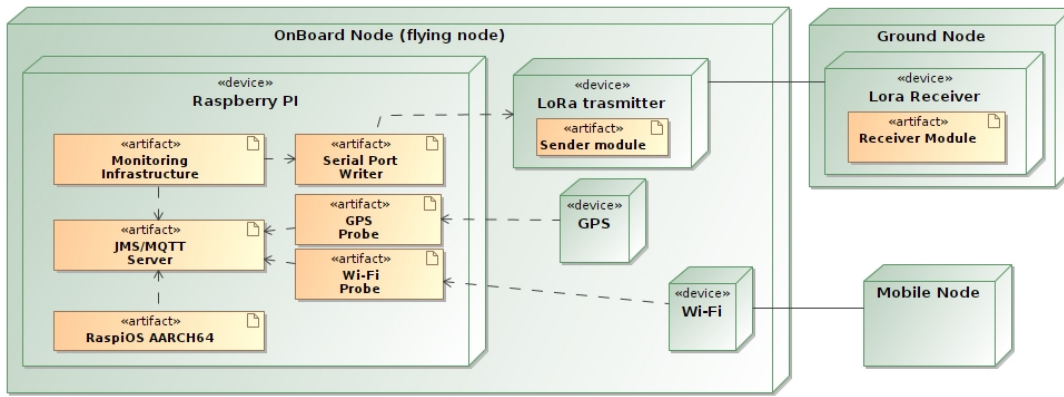

Figure 3. Infrastructure of the proposed system

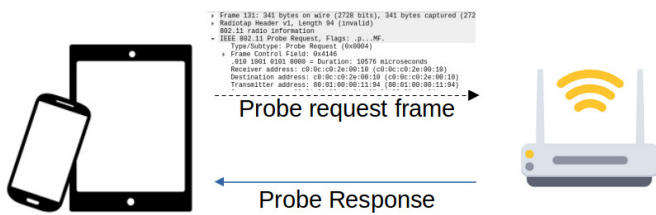

Figure 4. Probe request process executed by any Wi-Fi device

on which events generated by probes are sent to the *CEP* for being analyzed. In order to capture correctly an event, we must consider *Timestamp*, *Sender*, *Destination*, *EventName*, *EventData* parameters. In Figure: 5 the hierarchy between the *Event<T>* interface and *ConcernAbstractEvent<T>* abstract class is depicted.

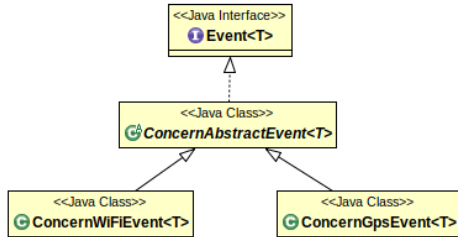

Figure 5. Class diagram of events used for event-based monitoring

To enhance precision and speed of the CEP analysis, the event object has been extended through *ConcernGPSEvent<T>* and *ConcernWiFiEvent<T>* objects in order to capture parameters useful to the analysis. The *ConcernGpsEvent<T>* contains information related to latitude and longitude captured by the GPS device. The *ConcernWiFiEvent<T>* contains information about *MAC Address* and to the *receivedDb* that refers to the power of signal captured and also using the *PacketType* field system may speeding up analysis about frame type captured.

IV. USE CASE DESCRIPTION

The main scenario on which the system will be tested is a woods environment. We suppose that a person loses his way back or suffers a more or less serious accident in an area characterized by dense bush and lack of cellular service coverage, which prevents him from sending emergency requests, if he is conscious, or from being tracked down via base station triangulation by the rescuers. In woods, usually we can find inexperienced hikers, therefore to speed up rescue operations it is necessary to provide more efficient support of visual analysis through cameras on board the drone as it is performed actually, especially considering that dense bush could inhibit photographic analysis. For this scope, the system will be configured for capturing data (i.e., *Probe request*, *Beacon*), associate it with the GPS position gathered from GPS module and notify in through *LoRa* to the *Ground Station* or directly to the *Terrestrial rescuer*. Once the system has been set-up and all the components involved are running, the mission can start and the *Drone pilot* will fly the drone above the woods. The interaction occurred within the system are shown in Figure 6. The *GPS Probe* retrieves information from the GPS module notifying it to the *Monitoring Infrastructure* (messages 1, 2 and 3). The external *Wi-Fi* module, configured in monitor mode is attempting to intercept any packet (message 5), according to the procedures described in Section III-C. The message 6 is represented by an UML element, called *Found Message*, which identifies a message without a known sender but which can have a recipient, in this case has been sent in broadcast. The *Wi-Fi Probe* receives the message captured by the *Wi-Fi* module, extracts the *MAC Address*, create the event described in Section III-D (message 8) and notify it through the *JMS/MQTT Server* message broker (message 9) to the *Monitoring Infrastructure* (message 10). *Monitoring Infrastructure* will perform inference analysis between the messages and the rules contained in its knowledge base (message 11) and if the messages received can be considered valid, a notification (12) will be sent to the *Serial Port Writer*, containing the data to be transmitted to the *Ground Node*. The message, containing the GPS position where the data has been

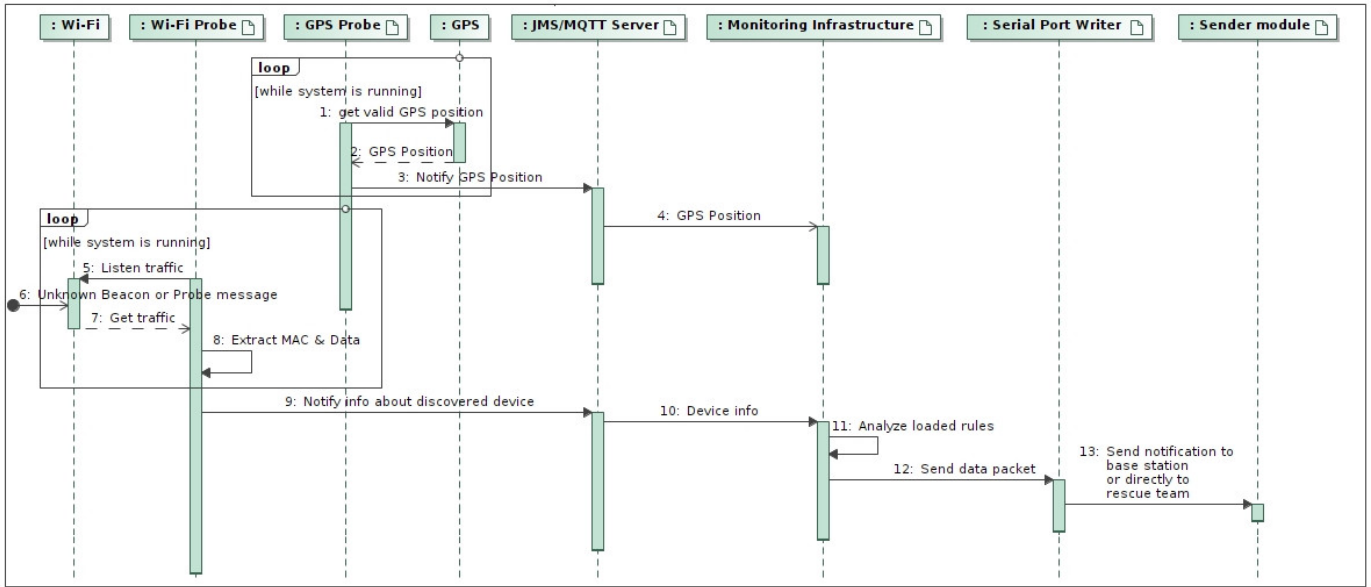

Figure 6. Activity diagram of the woods scenario.

captured, will be transmitted using the *LoRa* module managed by the *Sender Module* (message 13).

V. PERFORMANCE OF THE PROPOSED SAR SYSTEM

A. Testbed

In order to test the capability of the system, the hw device has been placed on top of a commercial drone as shown in Figure 7.a and the *LoRa Receiver Module* has been connected to the USB port of a smartphone as shown in Figure: 7.b.

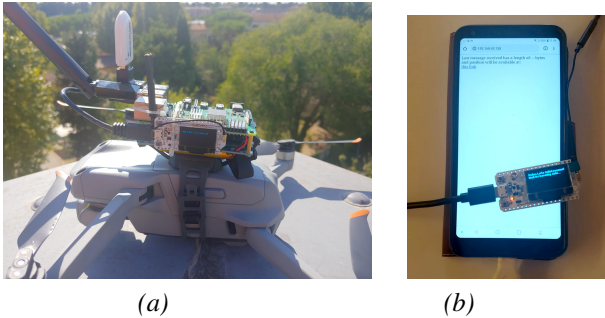

Figure 7. Testbed: (a) System installed on a commercial drone; (b) Receiver module connected to a smartphone.

The test has been executed in a woods where there are not any flight restrictions and there is not GSM coverage. A smartphone with Wi-Fi on has been left under a tree as shown in Figure: 8.b. An aerial image of the woods is shown in Figure: 8.a.

The OS installed on Raspberry-Pi⁵ is executing a script that run all the components, probes and put the external Wi-Fi antenna in monitor mode. *LoRa* device on boot is already listening on the emulated serial port for incoming data to

⁵Raspis AARCH 64bit

transmit to the *Ground Station*. The *Ground Station* consists on a mobile device on which is connected the *LoRa* device running the *Receiver Module* software. The *Receiver Module* has been developed for listening *LoRa* data over the air, but also for exposing a web server reachable through a Wi-Fi network in order to show the received *LoRa* messages. In Figure 7.b the smartphone connected to the web page exposed by the *Receiver Module* is shown.

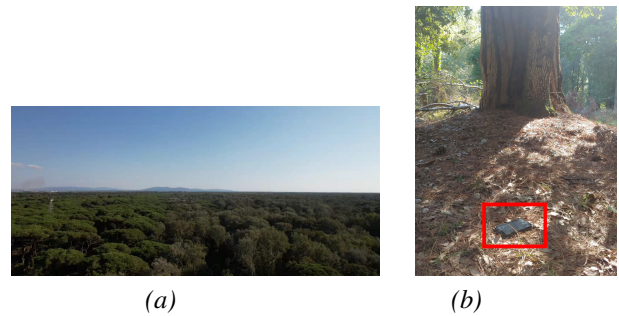

Figure 8. Testbed: (a) An aerial image of the testbed area; (b) The smartphone left in the woods.

B. Results of the measurement campaign

We evaluated the capacity of the UAV to detect the presence of the distressed person in a woods. The drone took off from a distance of 150 meters from the point of abandonment of the smartphone reaching an altitude of 35 meters. After that, it starts moving at a speed of 5.4 km per hour (1.5m/s). The first detection of the abandoned device occurred at a ground distance of 79 meters which, considering the flight height, indicates a distance of about 86.5 meters. Approaching to the device of the distress user, the density of the beacons received over a period of time has been increasing as shown in the

chart in Figure: 9. These results can be considered as a good starting point considering the exploited technology. For space reasons, no further tests carried out at different speeds and altitudes are reported.

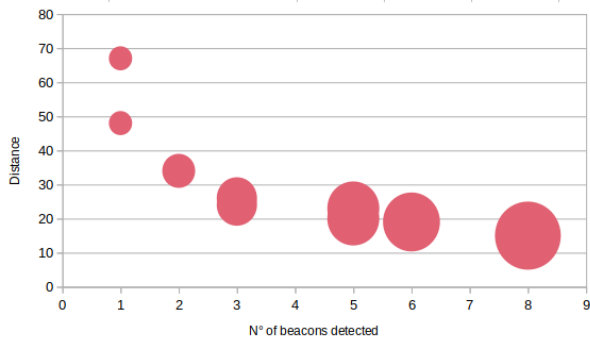

Figure 9. Beacons intensity received during the flight

VI. CONCLUSIONS

System proposed aims to merge advantages provided by radio communication (LoRa) with the support of UAV for SAR operation enhancing the detection through an artificial intelligence provided by the CEP. Hardware employed is not for professional usage, therefore this choice guarantees high availability at reduced costs, despite the low dependability, reliability and robustness provided in critical operating conditions (eg. low temperature, vibrations, etc.). The prototype presented, considering the performances and weight, lends itself to a lot of developments and improvements, ranging from the evolution of the intelligence provided by the CEP to scenarios involving mesh networks of drones with the generation of intra-drone radio links to conduct researches autonomously.

REFERENCES

- [1] C. Liu and T. Szirányi, "Real-Time Human Detection and Gesture Recognition for On-Board UAV Rescue," *Sensors*, vol. 21, no. 6, p. 2180, 2021.
- [2] D. Božić-Štulić, Ž. Marušić, and S. Gotovac, "Deep learning approach in aerial imagery for supporting land search and rescue missions," *International Journal of Computer Vision*, vol. 127, no. 9, pp. 1256–1278, 2019.
- [3] E. Lygouras, N. Santavas, A. Taitzoglou, K. Tarchanidis, A. Mitropoulos, and A. Gasteratos, "Unsupervised human detection with an embedded vision system on a fully autonomous uav for search and rescue operations," *Sensors*, vol. 19, no. 16, p. 3542, 2019.
- [4] N. Mimmo, P. Bernard, and L. Marconi, "Avalanche victim search via robust observers," *IEEE Transactions on Control Systems Technology*, vol. 29, no. 4, pp. 1450–1461, 2020.
- [5] M. H. Khyavi, "Rescue network: Using uavs (drones) in earthquake crisis management," 2021.
- [6] C. Tabasso, N. Mimmo, V. Cichella, and L. Marconi, "Optimal motion planning for localization of avalanche victims by multiple UAVs," *IEEE Control Systems Letters*, vol. 5, no. 6, pp. 2054–2059, 2021.
- [7] A. Albanese, V. Sciancalepore, and X. Costa-Pérez, "SARDO: An automated search-and-rescue drone-based solution for victims localization," *arXiv preprint arXiv:2003.05819*, 2020.

- [8] R. Sanchez-Iborra, J. Sanchez-Gomez, J. Ballesta-Viñas, M.-D. Cano, and A. F. Skarmeta, "Performance evaluation of LoRa considering scenario conditions," *Sensors*, vol. 18, no. 3, p. 772, 2018.
- [9] M. O. Ojo, D. Adami, and S. Giordano, "Experimental Evaluation of a LoRa Wildlife Monitoring Network in a Forest Vegetation Area," *Future Internet*, vol. 13, no. 5, p. 115, 2021.
- [10] R. Sanchez-Iborra and M.-D. Cano, "State of the art in LP-WAN solutions for industrial IoT services," *Sensors*, vol. 16, no. 5, p. 708, 2016.
- [11] R. Sanchez-Iborra, J. Sanchez-Gomez, and A. Skarmeta, "Evolving IoT networks by the confluence of MEC and LP-WAN paradigms," *Future Generation Computer Systems*, vol. 88, pp. 199–208, 2018.
- [12] G. Codeluppi, A. Cilfone, L. Davoli, and G. Ferrari, "LoRaFarM: A LoRaWAN-based smart farming modular IoT architecture," *Sensors*, vol. 20, no. 7, p. 2028, 2020.
- [13] L. Vangelista and A. Cattapan, "Extending the Lora modulation to add parallel channels and improve the LoRaWAN network performance," in *2021 11th IFIP International Conference on New Technologies, Mobility and Security (NTMS)*. IEEE, 2021, pp. 1–5.
- [14] R. Kloibhofer, E. Kristen, and L. Davoli, "Lorawan with hsm as a security improvement for agriculture applications," in *International Conference on Computer Safety, Reliability, and Security*. Springer, 2020, pp. 176–188.
- [15] G. M. Bianco, R. Giuliano, G. Marrocco, F. Mazzenga, and A. Mejia-Aguilar, "LoRa System for Search and Rescue: Path-Loss Models and Procedures in Mountain Scenarios," *IEEE Internet of Things Journal*, vol. 8, no. 3, pp. 1985–1999, 2020.
- [16] C. Bouras, A. Gkamas, and S. A. K. Salgado, "Exploring the energy efficiency for Search and Rescue operations over LoRa," in *2021 11th IFIP International Conference on New Technologies, Mobility and Security (NTMS)*. IEEE, 2021, pp. 1–5.
- [17] R. P. Centelles, R. Meseguer, F. Freitag, L. Navarro, S. F. Ochoa, and R. M. Santos, "LoRaMoto: A communication system to provide safety awareness among civilians after an earthquake," *Future Generation Computer Systems*, vol. 115, pp. 150–170, 2021.
- [18] M. Mansouri-Samani and M. Sloman, "Monitoring distributed systems," *IEEE network*, vol. 7, no. 6, pp. 20–30, 1993.
- [19] A. O. Strube, D. Rexachs, and E. Luque, "Software probes: A method for quickly characterizing applications' performance on heterogeneous environments," in *2009 International Conference on Parallel Processing Workshops*. IEEE, 2009, pp. 262–269.
- [20] A. Bertolino, A. Calabrò, and G. De Angelis, "Adaptive sla monitoring of service choreographies enacted on the cloud," in *2013 IEEE 7th International Symposium on the Maintenance and Evolution of Service-Oriented and Cloud-Based Systems*. IEEE, 2013, pp. 92–101.
- [21] S. Khan, S. Nazir, I. García-Magariño, and A. Hussain, "Deep learning-based urban big data fusion in smart cities: Towards traffic monitoring and flow-preserving fusion," *Computers & Electrical Engineering*, vol. 89, p. 106906, 2021.
- [22] F. Dotzer, L. Fischer, and P. Magiera, "Vars: a vehicle ad-hoc network reputation system," in *Sixth IEEE International Symposium on a World of Wireless Mobile and Multimedia Networks*, 2005, pp. 454–456.
- [23] P. Barsocchi, P. Cassara, F. Mavilia, and D. Pellegrini, "Sensing a city's state of health: Structural monitoring system by internet-of-things wireless sensing devices," *IEEE Consumer Electronics Magazine*, vol. 7, no. 2, pp. 22–31, 2018.
- [24] A. Calabrò, F. Lonetti, and E. Marchetti, "Access control policy coverage assessment through monitoring," in *Computer Safety, Reliability, and Security - SAFECOMP 2017 Workshops, ASSURE, DECSoS, SASSUR, TELERISE, and TIPS, Trento, Italy, September 12, 2017, Proceedings*, ser. Lecture Notes in Computer Science, S. Tonetta, E. Schoitsch, and F. Bitsch, Eds., vol. 10489. Springer, 2017, pp. 373–383. [Online]. Available: https://doi.org/10.1007/978-3-319-66284-8_31
- [25] P. Barsocchi, A. Calabrò, E. Ferro, C. Gennaro, E. Marchetti, and C. Vairo, "Boosting a low-cost smart home environment with usage and access control rules," *Sensors*, vol. 18, no. 6, p. 1886, 2018.
- [26] G. Castignani, A. Arcia, and N. Montavont, "A study of the discovery process in 802.11 networks," *ACM SIGMOBILE Mobile Computing and Communications Review*, vol. 15, no. 1, pp. 25–36, 2011.
- [27] J. Freudiger, "How talkative is your mobile device? an experimental study of wi-fi probe requests," in *Proceedings of the 8th ACM Conference on Security & Privacy in Wireless and Mobile Networks*, 2015.